

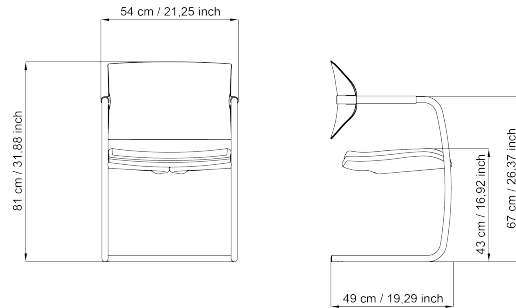





AIRE JR

Design Stefano Getzel

article: 407B
code: 4AIFC12



					
9	no	2	11	0,39	57x124 x56
EN 16139	EN 1728	CAM	VOC	Warranty: 5 years	

DESCRIPTION

Group Seating, medium backrest, pvc armrests, chromed structure, anti-overturning glide.

FINISHING: plastic back: clear, white, grey and sand coloured; grey seat support and armrests. Plastic back: black; black seat support and armrest.

BACK: in opaque polypropylene finish.

SEAT: in fire-retardant foam, density 50 kg/m³ with multi-layer beech and poplar seat insert and covering seat support in polypropylene.

ARMRESTS: produced with thermal shaping system pvc black or grey, combined with the seat support.

BASE: high resistant round steel diameter Ø 25 mm, chromed finishing.

MAINTENANCE

CHROME PLATED PARTS: Clean with a soft cloth with some neutral detergent to polish the steel.

PAINTED PARTS: Clean with soft cloth dampened slightly with water and dry with a dry cloth.

PLASTIC PARTS: Use soft cloth dampened slightly with water, without insistence, then dry with a dry cloth

ALUMINIUM PARTS: To clean use only specific products to polish metal parts in order to reduce the natural oxidation due to the hands contact. The aluminium parts tarnish naturally. LUXY recommends not using chemical detergents.

FABRIC: Fabric: pour some drops of neutral detergent on a damp and wringed out cloth, rub gently on the seat and leave it dry. See maintenance instructions on LUXY upholstery book. Luxy recommends using ecological products.

LEATHER: Leather is a natural product. Imperfections give to the material its unmistakable aspect. In presence of marks, they have to be removed with a soft wool cloth. In case of ingrained stains, use only products for leather coloured with aniline. Do not expose leather to direct sunlight. Luxy recommends using ecological products.

MATERIAL AND RECYCLABILITY

