

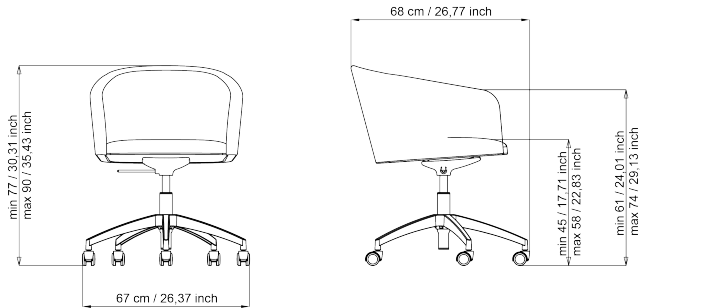





BLOOM

Design Air Design

article: BL25

code: 4BLFC90

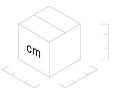

					
11	no	1	14,5	0,35	90x64x62

1IM	EN 16139	UNI 9175
-----	----------	----------

Warranty: 5 years

DESCRIPTION

Universal swivel chair, upholstered type XL shell, polished aluminum base with Ø 65 mm black wheels.

BACKREST: padding in fire-retardant polyurethane foam CLASS1 (ITALIAN) with double density 30 kg/m³ and 50 kg/m³ on different zones, with 1.2 mm thick steel sheet insert.

SEAT: padding in fire-retardant polyurethane foam CLASSE1 (ITALIAN) density 50 kg/m³, with double insert in multilayer wood.

STRUCTURE: 5-star swivel and gas lift base in aluminum finish and black auto-braked wheels Ø 65 mm.

MAINTENANCE

CHROME PLATED PARTS: Clean with a soft cloth with some neutral detergent to polish the steel.

PAINTED PARTS: Clean with soft cloth dampened slightly with water and dry with a dry cloth.

PLASTIC PARTS: Use soft cloth dampened slightly with water, without insistence, then dry with a dry cloth

ALUMINIUM PARTS: To clean use only specific products to polish metal parts in order to reduce the natural oxidation due to the hands contact. The aluminum parts tarnish naturally. LUXY recommends not using chemical detergents.

FABRIC: Fabric: pour some drops of neutral detergent on a damp and wringed out cloth, rub gently on the seat and leave it dry. See maintenance instructions on LUXY upholstery book. Luxy recommends using ecological products.

LEATHER: Leather is a natural product. Imperfections give to the material its unmistakable aspect. In presence of marks, they have to be removed with a soft wool cloth. In case of ingrained stains, use only products for leather coloured with aniline. Do not expose leather to direct sunlight. Luxy recommends using ecological products.

MATERIAL AND RECYCLABILITY

0,00 %	52,06 %	0,00 %	17,62 %	16,37 %	7,53 %	6,42 %	100,00 %
STEEL	ALUMINIUM	NYLON	WOOD	CARTON	FOAM	UPHOLSTERY	RECYCLABLE