

**DISASSEMBLAGGIO / DISASSEMBLY INSTRUCTION**

# **SEDIE DA LAVORO**

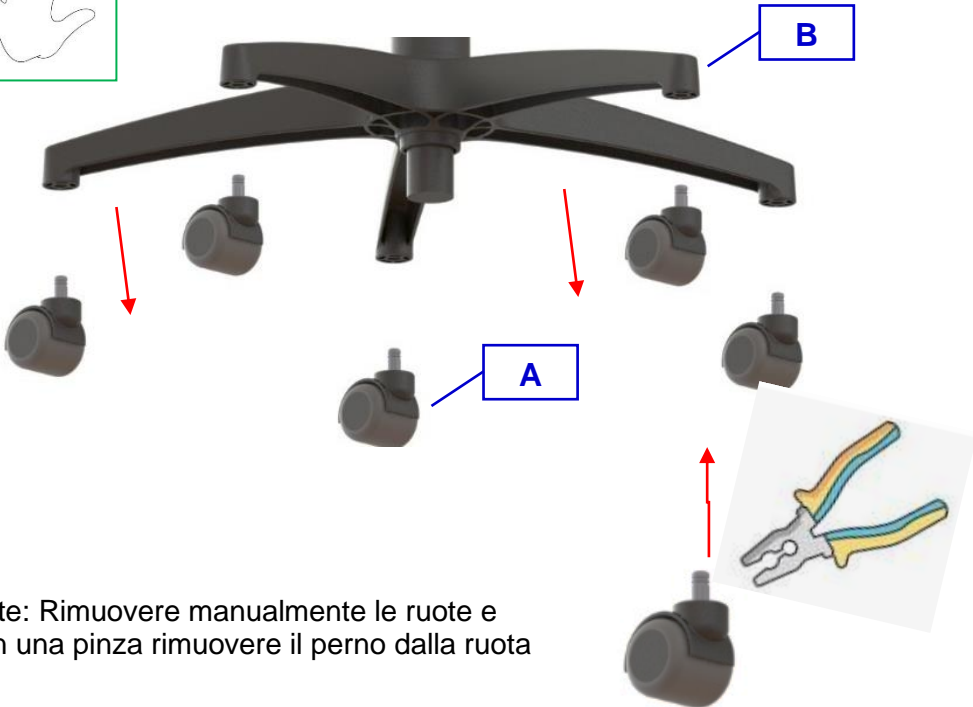

## **DISASSEMBLAGGIO RUOTE e/o PIEDINI DALLA BASE**



Note: Rimuovere manualmente le ruote e con una pinza rimuovere il perno dalla ruota

### **SMALTIMENTO / CONFERIMENTO**

N°	Componente		Materiale	Smaltimento
<b>A</b>	<b>RUOTE</b>	RUOTA	PLASTICA	PLASTICA
<b>A</b>	<b>RUOTE</b>	PERNO	FERRO	FERRO
<b>B</b>	<b>BASE</b>	/	PLASTICA o ALLUMINIO	PLASTICA o ALLUMINIO

## **DISASSEMBLAGGIO BASE GIREVOLE – ALZATA**

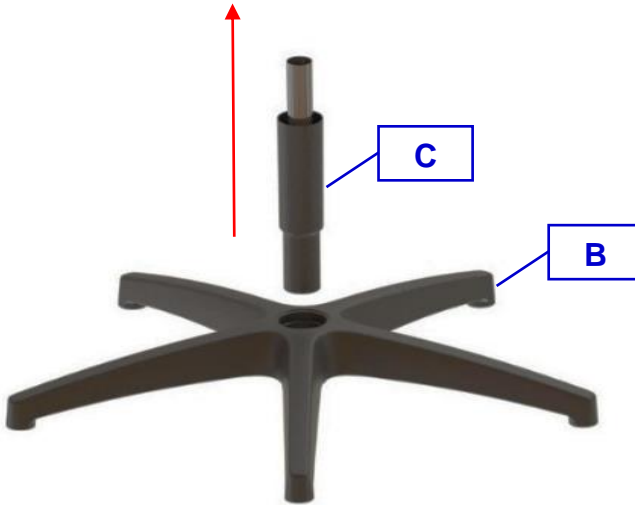

Note: Sfilare manualmente alzata e copri alzata dalla base.

## **SMALTIMENTO / CONFERIMENTO**

<b>N°</b>	<b>Componente</b>		<b>Materiale</b>	<b>Smaltimento</b>
<b>B</b>	<b>BASE</b>	/	PLASTICA o ALLUMINIO	PLASTICA o ALLUMINIO
<b>C</b>	<b>ALZATA GAS**</b>	/	FERRO e GAS	INDIFFERENZIATA

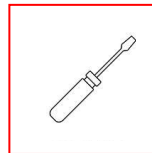
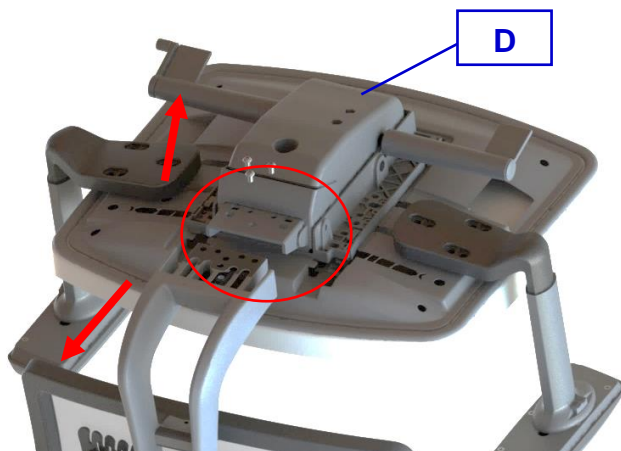
**DISASSEMBLAGGIO SCHIENALE dal MECCANISMO**

Note: Svitare con un cacciavite le viti che uniscono lo schienale dal meccanismo. Successivamente sfilare lo schienale.

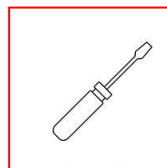
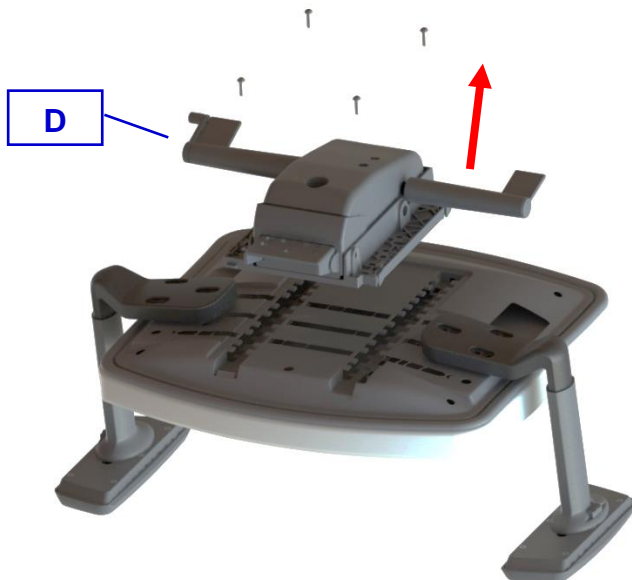

Note: Svitare con cacciavite le viti che uniscono il meccanismo al sottosedile e rimuoverlo.

## **DISASSEMBLAGGIO BRACCIOLI**

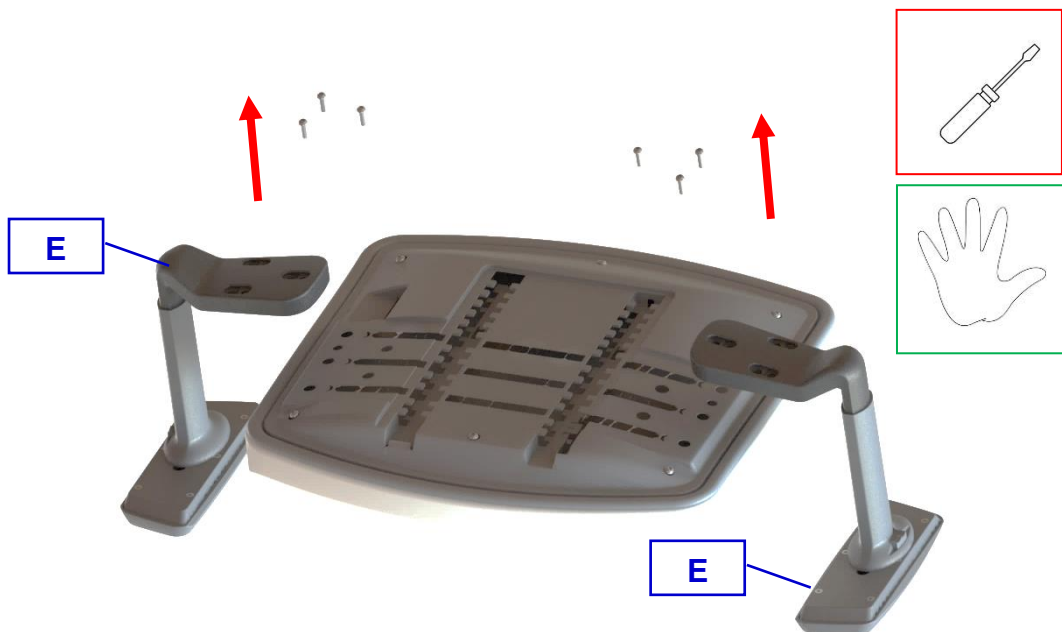

Note: Svitare con cacciavite le viti che uniscono i braccioli al sottosedile e rimuoverli.

## **SMALTIMENTO / CONFERIMENTO**

N°	Componente		Materiale	Smaltimento
<b>D</b>	<b>MECCANISMO</b>	/	FERRO	FERRO
<b>E</b>	<b>BRACCIOLO</b>	PAD	TPE	PLASTICA
<b>E</b>	<b>BRACCIOLO</b>	SUPPORTO	PLASTICA	PLASTICA
<b>E</b>	<b>BRACCIOLO</b>	STRUTTURA	PLASTICA o ALLUMINIO	PLASTICA o ALLUMINIO

**DISASSEMBLAGGIO SEDILE**

Note: Svitare con cacciavite il sotto-sedile dell'interno-sedile facendo leva con un cacciavite per separarli.

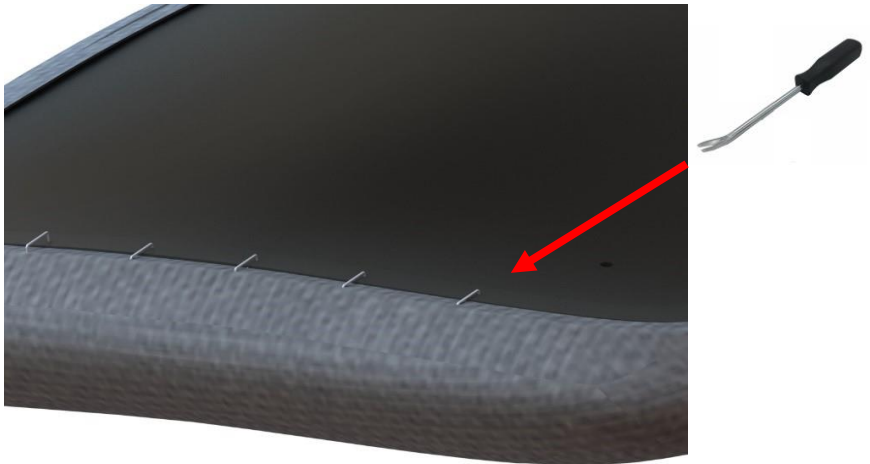

Note: Usare cacciavite levapunti per rimuovere le graffette dall'interno del sedile.



**G**

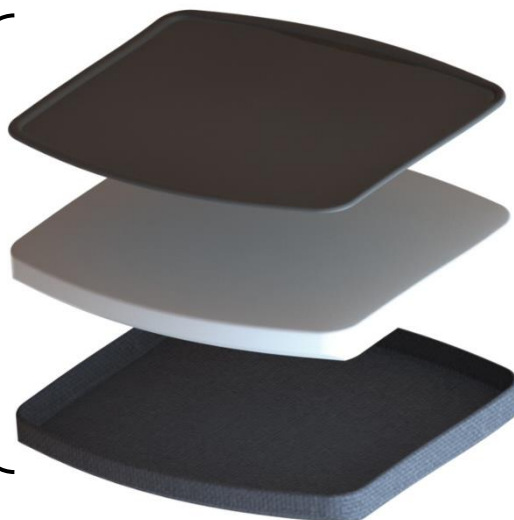

**SEDILE  
INTERNO**

**GOMMA**

**TESSUTO**

Note: Separare manualmente tessuto+gomma ed interno-sedile.

### **SMALTIMENTO / CONFERIMENTO**

<b>N°</b>	<b>Componente</b>		<b>Materiale</b>	<b>Smaltimento</b>
<b>F</b>	<b>SOTTOSEDILE</b>	/	PLASTICA o GOMMA	PLASTICA o LEGNO
<b>G</b>	<b>SEDILE</b>	SEDILE INTERNO	PLASTICA	PLASTICA
<b>G</b>	<b>SEDILE</b>	GOMMA	PLASTICA	PLASTICA
<b>G</b>	<b>SEDILE</b>	TESSUTO	PLASTICA	PLASTICA
<b>G</b>	<b>SEDILE</b>	TESSUTO SPALMATO	MISTO	INDIFFERENZIATA

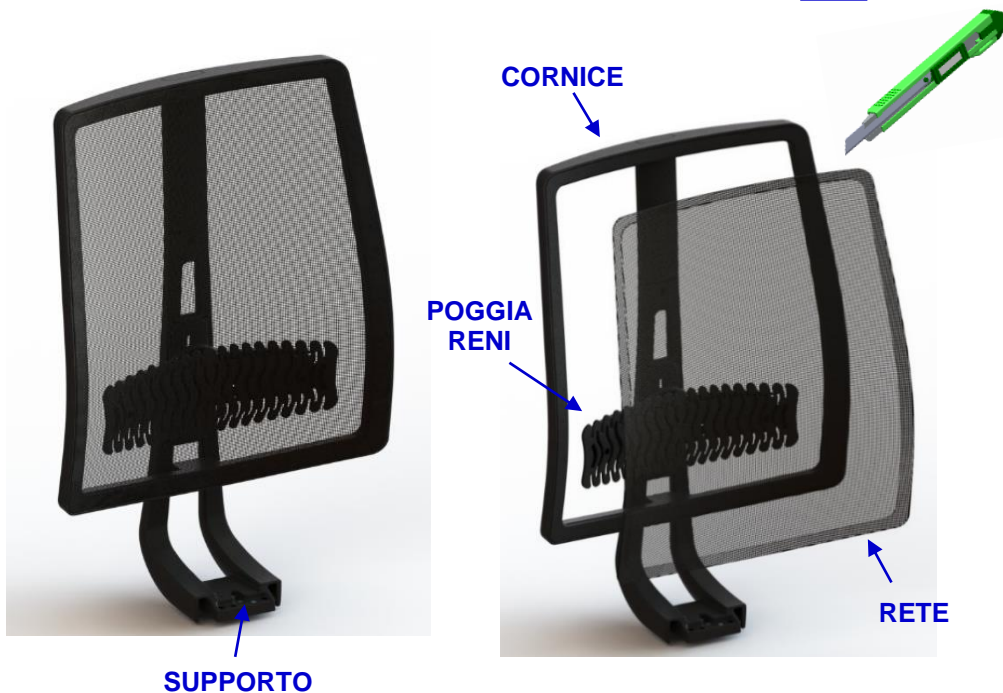
**DISASSEMBLAGGIO SCHIENALE RETE**
**H**

Note: Usare un CUTTER per tagliare la rete lungo i bordi dello schienale. Rimuovere manualmente il supporto e poggiategni.

**SMALTIMENTO / CONFERIMENTO**

N°	Componente		Materiale	Smaltimento
H	SCHIENALE	CORNICE	PLASTICA	PLASTICA
H	SCHIENALE	RETE	PLASTICA	PLASTICA
H	SCHIENALE	SUPPORTO	PLASTICA o ALLUMINIO	PLASTICA o ALLUMINIO
H	SCHIENALE	POGGIARENI	PLASTICA	PLASTICA



**DISASSEMBLAGGIO SCHIENALE IMBOTTITO (ove presente)**

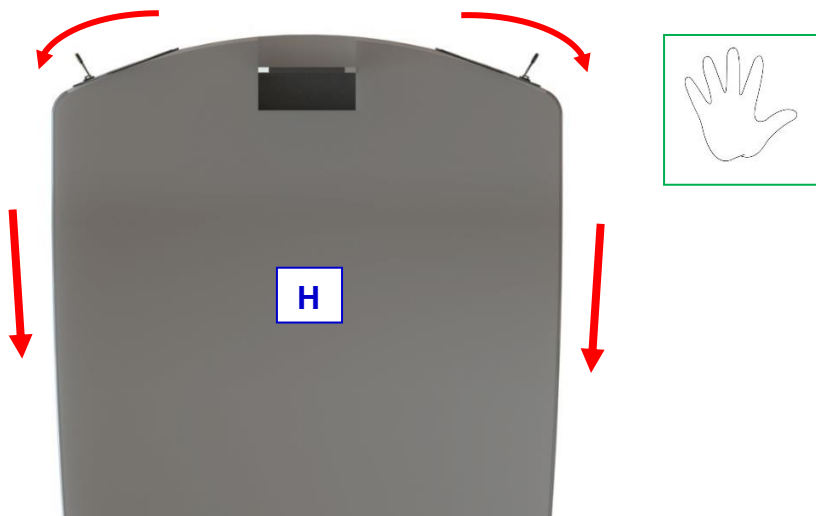

Note: IN CASO DI SCHIENALE IMBOTTITO, aprire le cerniere nella parte inferiore dello schienale e sfilare con forza il tessuto dallo schiumato.

**SMALTIMENTO / CONFERIMENTO**

N°	Componente		Materiale	Smaltimento
<b>H</b>	<b>SCHIENALE</b>	SCHIUMATO**	PLASTICA/FERRO	INDIFFERENZIATA
<b>G</b>	<b>SEDILE</b>	TESSUTO	PLASTICA	PLASTICA
<b>G</b>	<b>SEDILE</b>	TESSUTO SPALMATO	MISTO	INDIFFERENZIATA

## STRUMENTI UTILIZZATI



**CACCIAVITE**



**CUTTER**



**LEVA GRAFFETTE**